



OIL INDIA LIMITED
(A Government of India Enterprises)
PO : Duliajan – 786602
Assam (India)

TELEPHONE NO. (91-374) 2808757

FAX NO: (91-374) 2800533

Email: ankurjyoti_sarmah@oilindia.in ; erp_mm@oilindia.in

FORWARDING LETTER

Tender No. : SDI9228P19 DT: 18.09.2018
Tender Fee : NIL
Bid Security : Applicable
Bidding Type : SINGLE STAGE TWO BID SYSTEM
Bid Closing on : 29.11.2018 (11.00 HRS IST)
Bid Opening on : 29.11.2018 (14.00 HRS IST)
Performance Security : Applicable
Integrity Pact : Applicable

"The items covered by this enquiry shall be used by Oil India Limited in the PEL/ML areas which are issued/renewed after 01/04/99 and hence Nil Customs Duty during import will be applicable. However, concessional rate of GST @5% against Essentiality Certificate for invoice value 10 Lakh and above will be applicable.

In the event of order, OIL will issue Essentiality Certificate (EC), where concessional rate of GST @5% will be applicable. Supplier shall affect dispatch only on receipt of these certificates from OIL, failing which all related liabilities shall be to Supplier's account".

OIL invites Bids for **PROCUREMENT OF RECTANGULAR TANKS – 21 NOS** through its e-Procurement site under **SINGLE STAGE TWO BID SYSTEM**. The bidding documents and other terms and conditions are available at Booklet No. MM/LOCAL/E-01/2005 for E-Procurement of Indigenous Tenders. The prescribed Bid Forms for submission of bids are available in the Technical RFx -> External Area -> Tender Documents

The general details of tender can be viewed by opening the RFx [Tender] under RFx and Auctions. The details of items tendered can be found in the Item Data and details uploaded under **Technical RFX**.

The tender will be governed by:

- a) For technical support on various matters viz. Online registration of vendors, Resetting of Passwords, submission of online bids etc, vendors should contact OIL's ERP MM Deptt at following: Tel Nos. = 0374-2807178/ 2807171/ 2807192/2804903. Email id = erp_mm@oilindia.in.

b) **OIL's office timings are as below:**

	Time (in IST)
Monday – Friday	07.00 AM to 11.00 AM; 12.30 PM to 03.30 PM
Saturday	07.00 AM to 11.00 AM
Sunday and Holidays	Closed

Vendors should contact OIL officials at above timings only.

OIL Bank Details :

	Bank Details of Beneficiary	
a	Bank Name	STAE BANK OF INDIA
b	Branch Name	Duliajan
c	Branch Address	Duliajan, Dist-Dibrugarh
d	Banker Account No.	10494832599
e	Type of Account	Current Account
f	IFSC Code	SBIN0002053
g	MICR Code	786002302
h	SWIFT Code	SBININBB479
i	Contact No.	9435554859
j	Contact Person Name	Mr. K.L.K.Banik, AGM
k	Fax No.	0374-2802729
l	Email Id	sbi.02053@sbi.co.in

- c) "General Terms & Conditions" for e-Procurement as per Booklet No. MM/LOCAL/E-01/2005 for E-Procurement of Indigenous Tenders.
- d) Technical specifications and Quantity as per **Annexure – 1A**.
- e) The prescribed Bid Forms for submission of bids are available in the Technical RFx -> External Area -> Tender Documents.
- f) Amendments to the NIT after its issue will be published on OIL's website only. Revision, clarification, addendum, corrigendum, time extension etc. to the tender will be hosted on OIL website only. No separate notification shall be issued in the press. Prospective bidders are requested to visit website regularly to keep themselves updated.
- g) Any sum of money due and payable to the contractor (including Security Deposit refundable to them) under this or any other contract may be appropriated by Oil India Limited and set-off against any claim of Oil India Limited (or such other person or persons

contracting through Oil India Limited) for payment of sum of money arising out of this contract or under any other contract made by the contractor with Oil India Limited (or such other person or persons contracting through Oil India Limited).

- h) Bidder are advised to fill up the Technical bid check list (**Annexure EEE**) and Response sheet (**Annexure FFF**) given in MS excel format in Technical RFx -> External Area - > Tender Documents. The above filled up document to be uploaded in the **Technical Attachment**. For details please refer “Vendor User Manual” / “NEW INSTRUCTIONS”

Special Notes:

1.0

- a) Bidders who do not have E-tender Login ID and Password should complete their online registration **at least seven (7) days prior to the scheduled bid closing date** and time of the tender. For online registration, Bidder may visit the OIL’s E-tender site <https://etender.srm.oilindia.in/irj/portal>
- b) Necessary Login ID & Password will be issued by OIL only after submitting the complete online registration by the Bidder. In the event of late registration/incomplete registration by Bidder, OIL INDIA LIMITED shall not be responsible for late allotment of User ID & Password and request for bid closing date extension on that plea shall not be entertained by Company.
- c) MSE Units (manufacturers only and not their dealers/distributors) who are already registered with District Industry Centers or Khadi & Village Industries Commission or Khadi & Village Industries Board or Coir Board or National Small Industries Corporation or Directorate of Handicrafts & Handloom or any other body specified by Ministry of MSME are exempted from payment of Bid Security (EMD) irrespective of monetary limit mentioned in their registration, provided they are registered for the item they intend to quote/participate.
- d) For availing benefits under Public Procurement Policy (Purchase preference & EMD exemption), the interested MSE Bidders must ensure that they are the manufacturer/ service provider of tendered item(s) and registered with the appropriate authority for the said item(s). Bids without EMD shall be rejected, if the technical offer does not include a valid copy of relevant MSE Certificate issued by appropriate authority specifying the item as per tender. Therefore, it is in the interest of such MSE Vendors to furnish a copy of complete certificate to the concerned tender handling officer of **OIL at least seven (7) days prior to the scheduled Bid Closing Date of the tender**, seeking clarification/confirmation as to whether their registered item is eligible for EMD exemption or not. **Late communication in this regard and request for bid closing date extension on that plea shall not be entertained by Company.**

NOTE:

In case of MSE/PSUs/ Govt. Bodies / eligible institutions etc., they must apply to concerned tender handling officer, Materials Department, Oil India Limited, P.O. Duliajan, Assam-786602 for waiver of EMD upto one week prior to the Bid closing date (or as amended in e-portal).

2.0 The tender is invited under SINGLE STAGE-TWO BID SYSTEM. The bidders are required to submit both the “TECHNO-COMMERCIAL UNPRICED BID” and “PRICED BID” through electronic format in the OIL’s e-Tender portal within the Bid Closing Date and Time stipulated in the e-Tender.

2.1 Please ensure that Technical Bid / all technical related documents related to the tender are uploaded in the RFX Information > Technical Attachment only. The “TECHNO-COMMERCIAL UNPRICED BID” shall contain all techno-commercial details except the prices. Please note that no price details should be uploaded in Technical RFX Response.

2.2 The “PRICE BID” must contain the price schedule and the bidder’s commercial terms and conditions. For price upload area , please refer “NEW INSTRUCTIONS” Please refer Annex-BB for price schedule.

2.3 Offer not complying with above submission procedure will be rejected as per Bid Rejection Criteria mentioned in Annexure-CCC.

3.0 Please note that all tender forms and supporting documents are to be submitted through OIL’s e-Procurement site only except following documents which are to be submitted manually in sealed envelope super scribed with Tender no. and Due date to **DGM-Materials, Materials Department, Oil India Limited, Duliajan - 786602, Assam** on or before the Bid Closing Date and Time mentioned in the Tender.

- a) Original Bid Security
- b) Detailed Catalogue (if any)
- c) Any other document required to be submitted in original as per tender requirement

All documents submitted in physical form should be signed on all pages by the authorised signatory of the bidder and to be submitted in Duplicate.

4.0 Benefits to Micro & Small Enterprises (MSEs) as per OIL’s Public Procurement Policy for Micro and Small Enterprises (MSEs) shall be given. Bidders are requested to go through ANNEXURE – I of MM/LOCAL/E-01/2005 for E-Procurement of Indigenous Tenders for more details. MSE bidders are exempted from submission of Tender Fees and Bid Security/Earnest Money provided they are registered for the items they intend to quote. Bidders who are allowed to participate against the tender as MSEs must quote their own products failing which their bids will be rejected.

5.0 Bidders are requested to examine all instructions, forms, terms and specifications in the bid. Failure to furnish all information required as per the NIT or submission of offers not substantially responsive to the bid in every respect will be at the bidders risk and may result in rejection of its offer without seeking any clarifications.

6.0 Bidders must ensure that their bid is uploaded in the system before the tender closing date and time. Also, they must ensure that above documents which are to be submitted in a sealed envelope are also submitted at the above mentioned address before the bid closing date and time failing which the offer shall be rejected.

7.0 Bid must be submitted electronically only through OIL’s e-procurement portal. Bid submitted in any other form will be rejected.

8.0 **SINGLE STAGE TWO BID SYSTEM** shall be followed for this tender and only the PRICED-BIDS of the bidders whose offers are commercially and technically acceptable shall be opened for further evaluation.

9.0 a) **The Integrity Pact is applicable against this tender. Therefore, please submit the Integrity Pact document duly signed along with your quotation as per BRC. OIL shall be entering into an Integrity Pact with the bidders as per format enclosed vide**

Annexure DDD of the tender document. This Integrity Pact proforma has been duly signed digitally by OIL's competent signatory. The proforma has to be submitted by the bidder (along with the technical bid) duly signed (digitally) by the same signatory who signed the bid, i.e., who is duly authorized to sign the bid. Uploading the Integrity Pact with digital signature will be construed that all pages of the Integrity Pact has been signed by the bidder's authorized signatory who sign the Bid. If any bidder refuses to sign Integrity Pact or declines to submit Integrity Pact with the offer, their bid shall be rejected straightway.

b) The name of the OIL's Independent External Monitors at present are as under:

**i) SHRI RAJIV MATHUR, IPS (Retd.)
Former Director, IB, Govt. of India,
e-Mail ID : rajivmathur23@gmail.com**

**ii) SHRI SATYANANDA MISHRA, IAS (Retd.)
Former Chief Information Commissioner &
Ex-Secretary, DOPT, Govt. of India
E-Mail ID : satyanandamishra@hotmail.com**

**iii) SHRI JAGMOHAN GARG
EX-VIGILANCE COMMISSIONER, CVC
E-mail id: jagmohan.garg@gmail.com**

10.0 The tender shall be governed by the Bid Rejection & Bid Evaluation Criteria given in enclosed **Annexure-CCC**. However, if any of the Clauses of the Bid Rejection Criteria / Bid Evaluation Criteria (as per **Annexure-CCC**) contradict the Clauses of the tender and / or "General Terms & Conditions" as per Booklet No. MM/LOCAL/E-01/2005 for E-Procurement of Indigenous Tenders elsewhere, those in the BEC / BRC shall prevail.

11.0 To ascertain the substantial responsiveness of the bid OIL reserves the right to ask the bidder for clarification in respect of clauses covered under BRC also and such clarifications fulfilling the BRC clauses in toto must be received on or before the deadline given by the company, failing which the offer will be summarily rejected.

12.0 Please do refer the User Manual provided on the portal on the procedure How to create Response for submitting offer.

13.0 If Bank Guarantee is submitted towards 'Bid Security', then bidders have to ensure that the Bank Guarantee issuing bank indicate the name and detailed address (including e-mail) of their higher office from where confirmation towards genuineness of the Bank Guarantee can be obtained.

14.0 Delivery/collection Instructions in cases where transportation is in OIL's scope:

(i) the suppliers shall be required to deliver the Sundry consignments of weight less than 3 (Three) Tons at the godown/office/collection point of OIL's authorized transporter in various cities.

(ii) consignments weighing more than 3(Three) Tons shall be collected from the supplier's premises/loading points by OIL's authorized transporter.

(iii) the names of OIL's current authorized transporters are:

a) M/s Western Carriers (India) Ltd.

b) M/s DARCL Logistics Limited

Bidder's are requested to note the above delivery/collection instructions while submitting their offers.

15.0 The applicable GST on the Liquidated Damage if any, shall have to be borne by the seller. Accordingly, the Liquidated Damage shall be recovered from the seller along with applicable GST.

16.0 Bidders should fill-up and submit alongwith their bid an UNDERTAKING towards authenticity of information/documents furnished by them, as per enclosed ANNEXURE-K.

Please do refer "**NEW INSTRUCTION TO BIDDER FOR SUBMISSION**" for the above two points and also please refer "**New Vendor Manual (effective 12.0.2017)**" available in the login Page of the OIL's E-tender Portal.



Oil India Limited e-Procurement

User ID *

Password *

Logon Problems? [Get Support](#)

[Supplier Enlistment for E-Tender](#)

Important Note for New Portal Users:

[Click here to View Competability Settings](#)

[General Guidelines to bidders](#)

[Click for User Manuals](#)

Click here for the New Manual & Instruction

© 2012 Oil India Limited. All rights reserved.

[Click for Terms of use, Privacy Policy, Refund Policy Docs](#)

NOTE:

Bidders should submit their bids (preferably in tabular form) explicitly mentioning compliance / non compliance to all the terms and conditions of the NIT.

Yours Faithfully

**Sd-
(A J SARMAH)
SR. MANAGER MATERIALS (IP)
FOR : GM-MATERIALS (HoD)**

Tender No & Date: SDI9228P19 DT: 18.09.2018

BID REJECTION CRITERIA (BRC) / BID EVALUATION CRITERIA (BEC)

The following BRC/BEC will govern the evaluation of the bids received against this tender. Bids that do not comply with stipulated BRC/BEC in full will be treated as non responsive and such bids shall prima-facie be rejected. Bid evaluation will be done only for those bids that pass through the “Bid Rejection Criteria” as stipulated in this document.

Other terms and conditions of the enquiry shall be as per General Terms and Conditions vide MM/LOCAL/E-01/2005 for E-Procurement of Indigenous Tenders. However, if any of the Clauses of the Bid Rejection Criteria / Bid Evaluation Criteria (BRC / BEC) contradict the Clauses of the tender or MM/LOCAL/E-01/2005 elsewhere, those in the BRC / BEC shall prevail.

<u>Criteria</u>	Complied / Not Complied. (Remarks if any)
<p>1.0 BID REJECTION CRITERIA (BRC):</p> <p>The bid shall conform generally to the specifications, terms and conditions given in this document. Notwithstanding the general conformity of the bids to the stipulated specifications, the following requirements will have to be particularly met by the Bidders without which the same will be considered as non-responsive and rejected.</p> <p>A) TECHNICAL:</p> <p>1.0 <u>Bidder's qualification:</u></p> <p>1.1 The bidder shall be a manufacturer of skid mounted rectangular tank or fabricator of API 650 std tank.</p> <p>2.0 <u>Bidder's experience:</u></p> <p>2.1 The bidder shall have credential of successful execution of purchase order(s) / contract(s), for any of the following,</p> <p>a) Fabrication & supply of steel tank, of minimum 37.37 KL capacity, for quantity not less than 11 Nos., vide purchase order awarded in last 05 years from the original bid closing date of the tender, to any Oil and Gas Industry/company.</p> <p>b) Fabrication of tank as per API 650 std, of minimum 160 KL capacity, for quantity of not less than 2 nos., vide contract awarded in last 05 years from the original bid closing date of the tender, to any Oil and Gas Industry/company.</p>	

2.2 The bidder shall submit the details of it's experience credentials in a tabular format as shown below:

Column A : SI No

Column B : Client / Customer Name and Address/ E-mail address

Column C : Order No / Contract No. and date

Column D : Technical specifications of the items

Column E : Quantity supplied

Column F : Completion date

Column G: Ref no of Supporting document (copy to be enclosed). *

* Copy(ies) of documents to be enclosed in support of the supply experience are as follows:

(a) Purchase Order(s) / Contract document(s), and

(b) Any one or more of the following documents that confirms the successful execution of each of the Purchase Order(s) / contract(s) cited above.

- Completion certificates

- Performance report from the clients,

- Bill of lading,

- Delivery challan / invoice etc.

- any other documentary evidence that can substantiate the successful execution of each of the Purchase Orders / Contracts cited above.

Note:

a) The Purchase Order date need not be within 5 (five) years preceding original bid closing date of this tender. However, the execution of supply should be within 5 (five) years preceding original bid closing date of this tender.

b) Satisfactory supply/completion/installation report (if submitted) should be issued on client's official letterhead with signature and stamp

B) FINANCIAL:

a) Annual Financial Turnover of the bidder during **any of preceding 03 (three) financial / accounting years from the original bid closing date** should be at least **Rs. 108.68 Lakhs.**

b) Net Worth of the firm should be Positive for preceding financial / Accounting year **(FY: 2017-2018).**

Note -For (a) & (b):

Considering the time required for preparation of Financial Statements, if the last date of preceding financial / accounting year falls within the preceding six months reckoned from the original bid closing date and the Financial Statements of the preceding financial / accounting year are not available with the bidder, then the financial turnover of the previous three financial / accounting years excluding the preceding financial / accounting year will be considered. In such cases, the Net worth of the previous financial / accounting year excluding the preceding financial / accounting year will be considered. However, the bidder has to submit an affidavit/undertaking certifying that 'the balance sheet/Financial Statements for the financial year (As the case may be) has actually not been audited so far'.

Note:

a) For proof of Annual Turnover & Net worth any one of the following document must be submitted along with the bid:-

i) A certificate issued by a practicing Chartered Cost Accountant (with Membership Number and Firm Registration Number), certifying the Annual turnover & Net worth as per format prescribed in ANNEXURE-J.

OR

ii) Audited Balance Sheet along with Profit & Loss account.”

b) In case the bidder is a Central Govt. Organization/PSU/State Govt. Organization/Semi-State Govt. Organization or any other Central/State Govt. Undertaking, where the auditor is appointed only after the approval of Comptroller and Auditor General of India and the Central Government, their certificates may be accepted even though FRN is not available. However, bidder to provide documentary evidence for the same.

C) COMMERCIAL:

i) Validity of the bid shall be minimum 120 days from the Bid Closing Date.

ii) Bid security:

The bid must be accompanied by Bid Security of **Rs. 4,35,000.00** in OIL's prescribed format as Bank Guarantee in favour of OIL. The Bid Security may be submitted manually in sealed envelope superscribed with Tender no. and Bid Closing date to GM-Materials, Materials Department, Oil India Limited, Duliajan- 786602, Assam on or before the Bid Closing Date and Time mentioned in the Tender. **The Bank Guarantee towards Bid Security shall be valid for 7 months from Bid closing date. (i.e. upto 30.06.2019).**

Bid Security may also be paid online on or before the Bid Closing Date and Time mentioned in the Tender.

If bid security in ORIGINAL of above mentioned Amount and Validity is not received or paid online within bid closing date and time, the bid submitted through electronic form will be rejected without any further consideration.

For exemption for submission of Bid Security, please refer Clause No. 8.16 of General Terms and Conditions vide MM/LOCAL/E-01/2005 for E-Procurement of Indigenous Tenders.

The format of Bank Guarantee towards Bid Security (Annexure – VII) has been amended to Annexure – VII (Revised) and bidders should submit Bank Guarantee towards Bid Security as per Annexure – VII (Revised) only.

iii) Bids are invited under “Single Stage Two Bid System”. Bidders have to submit both the “Techno-commercial Unpriced Bids” and “Priced Bids” through electronic form in the OIL’s e-Tender portal within the bid Closing date and time stipulated in the e-tender. The Techno-commercial Unpriced

bid is to be submitted as per scope of works and Technical specification of the tender and the priced bid as per the online Commercial bid format. For details of submission procedure, please refer relevant para of General Terms and Conditions vide MM/LOCAL/E-01/2005 for E-Procurement of Indigenous Tenders. Any offer not complying with the above shall be rejected straightway.

iv) Performance Security:

The successful bidder shall submit Performance Security @ 10% of PO value within 30 days of receipt of the formal purchase order failing which OIL reserves the right to cancel the order and forfeit the Bid Security.

The Performance Security shall be in the following form :

A Bank Guarantee in the prescribed OIL's format valid for 90 days beyond delivery period and applicable warranty/guarantee period (if any).

Bidders should undertake in their bids to submit Performance Security as stated above.

The validity requirement of Performance Security is assuming despatch within stipulated delivery period and confirmation to all terms and conditions of order. In case of any delay in despatch or non-confirmation to all terms and conditions of order, validity of the Performance Security is to be extended suitably as advised by OIL.

However, PBG will be applicable only if value of Purchase Order exceeds Rs 5(five) lakhs.

v) The prices offered will have to be firm through delivery and not subject to variation on any account. A bid submitted with an adjustable price will be treated as non-responsive and rejected.

vi) Bids received after the bid closing date and time will be rejected. Similarly, modifications to bids received after the bid closing date & time will not be considered.

vii) All the Bids must be Digitally Signed using "Class 3" digital certificate with Organisation's name (*e-commerce application*) as per Indian IT Act obtained from the licensed Certifying Authorities operating under the Root Certifying Authority of India (RCAI), Controller of Certifying Authorities (CCA) of India. The bid signed using other than "Class 3 with Organisation's Name" digital certificate, will be rejected.

viii) **Technical RFX Response folder is meant for Technical bid only. Therefore, No price should be given in Technical RFX Response folder, otherwise the offer will be rejected.**

ix) Price should be maintained in the "online price schedule" only. The price submitted other than the "online price schedule" shall not be considered.

x) A bid shall be rejected straightway if it does not conform to any one of the following clauses:

(a) Validity of bid shorter than the validity indicated in the Tender.

(b) Original Bid Security not received within the stipulated date & time mentioned in the Tender.

(c) Bid Security with (i) Validity shorter than the validity indicated in Tender and/or (ii) Bid Security amount lesser than the amount indicated in the Tender.

(d) In case the Party refuses to sign Integrity Pact.

(e) Annual Turnover of a bidder lower than the Annual turnover mentioned in the Tender.

XI) DELIVERY PERIOD: The maximum allowable delivery period in weeks/months after receipt of PO shall be 9 months.

NOTE: FOR CLAUSE NOS. C(ii) & C(iv) OF BID SECURITY/EMD AND PBG.

The bidders/successful bidders are requested to advise the Bank Guarantee issuing bank to comply with the following and ensure to submit, the receipt of the copy of SFMS message as sent by the issuing bank branch, along with the original bank guarantee in OIL's tender issuing office:

The bank guarantee issued by the bank must be routed through SFMS platform as per following details:

(i) "MT 760 / MT 760 COV for issuance of bank guarantee.

(ii) "MT 760 / MT 767 COV for amendment of bank guarantee

The above message/intimation shall be sent through SFMS by the BG issuing bank branch to Axis Bank, Duliajan Branch, IFS Code - UTIB0001129, Branch Address - AXIS Bank Ltd, Duliajan Branch, Daily Bazar, Jyotinagar, Duliajan, District - Dibrugarh, PIN- 786602

2.0 BID EVALUATION CRITERIA (BEC)

The bids conforming to the terms and conditions stipulated in the tender and considered to be responsive after subjecting to the Bid Rejection Criteria as well as verification of original of any or all documents/ documentary evidences pertaining to BRC, will be considered for further evaluation as per the Bid Evaluation Criteria given below. The original Bid Closing Date shall be considered by OIL for evaluation of BRC criteria even in case of any extension of the original Bid Closing Date.

A) TECHNICAL:

i) The bids will be evaluated strictly as per NIT specifications, terms & conditions.

B) COMMERCIAL:

i) To evaluate the inter-se-ranking of the offers, all Taxes / Levies will be considered as per prevailing Govt. guidelines as applicable on the bid opening date. Bidders may check this with the appropriate authority before submitting their offer.

<p>ii) Priced bids of only those bidders will be opened whose offers are found technically acceptable. The technically acceptable bidders will be informed before opening of the "priced bid".</p> <p>iii) A job executed by a bidder for its own organization / subsidiary cannot be considered as experience for the purpose of meeting BEC.</p> <p>iv) To ascertain the substantial responsiveness of the bid OIL reserves the right to ask the bidder for clarification in respect of clauses covered under BRC also and such clarifications fulfilling the BRC clauses in toto must be received on or before the deadline given by the company, failing which the offer will be summarily rejected.</p>	
--	--

NOTE:

Bidders should submit their bids (preferably in tabular form) explicitly mentioning compliance / non compliance to all the terms and conditions of the NIT.

-----XXXX-----

TECHNICAL SPECIFICATIONS WITH QUANTITY

Tender No & Date: SDI9228P19 DT: 18.09.2018

	Complied / Not Complied. (Remarks if any)
<p><u>ITEM NO. 10</u></p> <p><u>PROCUREMENT OF 37.37 KL RECTANGULAR TANK WITH GUARD RAILING WITH SLIP RESISTANCE SURFACE AT TOP [QTY: 04 NOS.]</u></p> <p><u>Item Description:</u> 37.37 kls capacity, 7500 mm x 2500 mm x 2150 mm skid mounted with roof rectangular crude oil storage tank out of 6 mm thick IS: 226 MS plates, with all welded on structure and complete with manholes, ladder, and other accessories as per details shown in OIL Drg. no. OIL/2984/C.</p> <p><u>The tanks shall be ADDITIONALLY equipped with the followings:</u></p> <p>a) The clean out door shall be fitted in an extended neck frame of minimum 2" height, using 50 x 50 x 6 mm ms angle plates welded to the tank wall, such that all bolts to the cover can be accessed from outside.</p> <p>b) Both 4" inlet & 6" outlet of the tank shall be extended to 12" by suitably supported spacer spools from tank wall and the openings shall be of flanged end connection (as per ANSI B16.5).</p> <p>c) A 1 feet (approximately) x 6" size long bend shall be threaded to the inside end of the suction flange (the end shall be positioned downward), so that the dead volume level can be lowered by another 4".</p> <p>d) A 4" NB coupling with plug shall be provided at the centre of the middle cover (tank top) to facilitate riser attachment / flame arrestor.</p> <p>e) <u>DIP HATCH:</u> A dip hatch of 3" dia with suitable opening / closing facility shall be provided at the center of the rectangular manhole cover (tank top), nearest to the 6" delivery connection of the tank. An additional ms plate of size 8" x 8" x 6 mm shall be welded to the tank bottom plate, where the dip bob will hit during dipping.</p> <p>f) <u>VALVES:</u> The tanks shall be complete with API 600 x 150 class gate valves with companion flanges and stud & bolts for inlet and outlet of the tanks. The valves shall be supplied from any one of the following make: M/s AIL, M/s L&T, M/s LACIER Industries & M/s KSB pumps Ltd.</p> <p>g) <u>GUARD RAILING:</u> The tanks shall be provided with guard railing as per drawing nos. OIL/ 10404 & OIL/10405.</p> <p>h) <u>PAINTING:</u> The painting of the tanks shall be carried out as below-</p> <p>i. <u>INTERNAL LINING:</u> The tank internal including the roof shall be coated with High</p>	

temperature resistant & chemical resistant anticorrosive solvent free ceramic reinforced composite / amine cured phenolic epoxy resin (novolac) coating.

ii. The coating shall have 100% solid by Volume, and Mixed Density / specific gravity 1.25 gm/cc Minimum. The Dry Film Thickness (DFT) 300 to 600 microns, two coat system with minimum 150 micron per coat. Dry film thickness shall be measured after each coat using thickness gauge e.g. Mikrotest, Elcometer or any other suitable instruments. Holiday or spark testing shall be done after application of last coat to find nicks, scrapes and pin holes in the coating.

iii. The coating shall have tensile shear / Pull off adhesion of Minimum 200 kg/sq cm (2840 psi) as per ASTM D 1002 / ASTM D 4541 / ISO 4624. The coating shall be chemical resistant to mixture of crude oil & water in continuous emersion as per ASTM D543 / ISO 2812-2. Service temperature shall be Minimum 80 Deg C in Wet (Immersion) service condition and Minimum 100 Deg C in Dry service condition as per ASTM D 648.

iv. The Surface preparation shall be achieved by abrasive/shot blasting to near white metallic as per NACE No. 2/SSPC-SP10, ISO 8501-1, Sa 2 ½ , with blast surface profile depth of 75 -125 micron. Profile measurement for abrasive blast cleaned surface shall be made with Testex Press-O-Film or other suitable method. Prior to blasting, all weld spatters shall be removed & sharp or rough welds rounded & contoured. Any change in the surface preparation recommended by the OEM of the coating system shall be forwarded in the technical bid for approval by OIL. The application shall be airless spray method.

v. The paint / coating shall be of make Hempel / Belzona / Chesterton / Akzo Nobel and Performance Guarantee shall be provided by the OEM of the coating for 10 years minimum for product as well as application procedure.

i) WALKWAY AT TOP SURFACE: There shall be an 7.5 m long & 0.6 m wide antiskid walkway surface at top surface of the tank, from ladder area to opposite end of the tank. The walkway surface shall be coated with slip resistant surface Polymer /Ceramic base coating having hard wearing aggregates. The coating shall be 100 % solid with Dry Film Thickness (DFT) 4 to 6 mm. Dry film thickness shall be measured after each coat using thickness gauge e.g. Mikrotest, Elcometer or any other suitable instruments.

The coating shall have Tensile shear / pull off adhesion of Minimum 200 kg/sq cm (2840 psi) as per ASTM D 1002 / ASTM D 4541 / ISO 4624. The coating shall be chemical resistant to crude oil and solvent.

i. The Surface preparation shall be achieved by abrasive/shot blasting to near white metallic as per NACE No. 2/SSPC-SP10, ISO 8505-1, Sa 2 ½ , with blast surface profile depth of 75 -125 micron. Profile measurement for abrasive blast cleaned surface shall be made with Testex Press-O-Film or other suitable method. Prior to blasting, all weld spatters shall be removed & sharp or rough welds rounded & contoured. Any change in the surface preparation recommended by the OEM of the coating system shall be forwarded in the technical bid for approval by OIL.

The application shall be carried by applicator tools as per recommendation of OEM of the coating system.

The paint / coating shall be of make Hempel / Belzona / Chesterton / Akzo Nobel and Performance Guarantee shall be provided by the OEM of the coating for 10 years minimum for

product as well as application procedure.

j) EXTERNAL SURFACES OF TANK (EXCEPT WALKWAY SURFACE) & GUARD RAILINGS: All external surfaces of the tank (excluding the walkway at top surface), and guard railings shall be painted with one coat of red oxide primer and followed by two coats of "grey colour" synthetic enamel paint.

Prior to painting, surface shall be prepared by cleaning of any dirt, contaminants, scale etc. by wire brush & high pressure water jet. Also, any oil & grease present shall be removed by solvent cleaning method, and properly dried. Application shall be by brush, or spray.

The paint / coating shall be of make Berger / Asian Paint / Akzo Nobel (ICI) / Nerolac.

k) SKID: Skid shall be painted with surface resistant high solids, high build, fast drying, polyamide cured epoxy mastic coating designed to protect steel. The coating shall have minimum 70% solid by Volume, VOC Level : < 300 g/l as per EPA Method 24, and Mixed Density / specific gravity 1.25 gm/cc Minimum. The Dry Film Thickness of the coating shall be 100 to 300 microns. Dry film thickness shall be measured after each coat using thickness gauge e.g. Mikrotest, Elcometer or any other suitable instruments.

The coating shall have Tensile shear adhesion 50 kg/sq cm (710 psi) Minimum and shall be chemical resistant to crude oil & water with service temperature Minimum 100 Deg C Dry.

The surface should be prepared with abrasive/shot blasting to near white metallic as per NACE No. 2/SSPC-SP10, ISO 8501-1, Sa 2 ½ , with blast surface profile depth of 75 -125 micron. Prior to blasting, the surface shall be made free of oil, grease and other foreign materials by solvent cleaning method as outlined in SSPC-SP-1. Profile measurement for abrasive blast cleaned surface shall be made with Testex Press-O-Film or other suitable method. Any change in the surface preparation recommended by the OEM of the coating system shall be forwarded in the technical bid for approval by OIL.

The application shall be carried by applicator tools as per recommendation of OEM of the coating system.

The paint / coating shall be of make Hempel / Belzona / Chesterton / Akzo Nobel and Performance Guarantee shall be provided by the OEM of the coating for 10 years minimum for product as well as application procedure.

ITEM NO. 20

PROCUREMENT OF 37.37 KL RECTANGULAR TANK WITH GUARD RAILING WITH SLIP RESISTANCE SURFACE AT TOP [QTY: 05 NOS.]

Item Description: SAME AS ITEM NO. 10

ITEM NO. 30

PROCUREMENT OF 37.37 KL RECTANGULAR TANK WITH GUARD RAILING WITH SLIP RESISTANCE SURFACE AT TOP [QTY: 12 NOS.]

Item Description: SAME AS ITEM NO. 10

SPECIAL TERMS & CONDITIONS:

- 1.0 The bidder shall confirm that the goods, materials to be supplied shall be new, of recent make, of the best quality & workmanship.
- 2.0 The bidder shall comment on all NIT point shall be given categorically (point wise). General comment like "agreed to all point of the NIT" etc. shall not be entertained during the evaluation.
- 3.0 The bidder must confirm that all MS plates and angles required for fabrication of the tank shall conform to IS 226.
- 4.0 The bidder must confirm that steel used for all items must be tested quality and conform to the specifications as per details shown in the drawing nos. **OIL/2984/C, OIL / 10404 & OIL/10405**. The soft copies of the drawings are enclosed with the NIT.
- 5.0 The bidder shall submit product catalogue, cross sectional drawing with material specifications of API 600 valve from the concerned original equipment manufacturer along with the technical offer.
- 6.0 The bidder shall submit technical details with product catalogue from the original equipment manufacturer of paint / coatings to be applied along with the technical offer.
- 7.0 The bidder shall confirm that necessary warranty / guarantee shall be provided from the original equipment manufacturer of paint /coatings along with supply of material.
- 8.0 The bidder shall confirm that the tank shall be embossed with the followings:
 - a) "OIL INDIA LIMITED"
 - b) Purchase order no.
 - c) Manufacturer's name
 - d) Serial no. of tank
- 9.0 **Third party inspection:** The materials shall be inspected by any of OIL's approved third party inspection agency (viz. M/s Lloyds or M/s Bureau Veritas or M/s Rites or M/s DNV or M/s IRS or M/s Tuboscope Vecto only) covering the following aspects to ensure conformance to IS 2062 / 226 standard (latest edition).
 - Metallurgy
 - Welding
 - Anticorrosive Painting
 - ND testing
 - Dimensions
 - Hydro test
- 10.0 Necessary test certificates for raw materials from reputed test house/ laboratory shall be submitted to the third party inspector for verification, and the verified test certificates shall be supplied to OIL in original along with supply.
- 11.0 All these scope of inspection to be included in the QAP / ITP (quality assurance plan or inspection test plan) which is to be submitted by the manufacture and to be approved by OIL as well as the concerned TPI agency.
- 12.0 **Inspection by OIL:** Inspection of the tanks shall be carried out in stages by OIL's Engineer as detailed below:
 - a) Initial inspection after completion of fabrication, for Raw Material, Workmanship & painting.
 - b) Hydraulic Testing & Final inspection.
- 13.0 OIL reserves the right to depute oil's engineer for inspection of materials at the manufacturing facility along with the TPI agency and the supplier has to arrange for the joint inspection accordingly by informing at least 15 days in advance. The bidder has to arrange for necessary instruments, along with

valid calibration certificate, for measuring DFT of the paint/ coating during such inspection. However, inspection by OIL's engineer will remain at its discretion.

14.0 The bidder has to furnish **Guarantee certificate** for satisfactory performance of the tanks **for a period of 24 months from the date of commissioning**. Any discrepancy that may occur during this period must be attended and rectified / replaced by the supplier at site of installation at their own arrangement and cost taking all necessary safety measures practiced in Oil India Limited.

15.0 Any materials/components found defective / damaged during transit shall have to be replaced / repaired by the supplier at free of cost.

NOTE:

Bidders should submit their bids (preferably in tabular form) explicitly mentioning compliance / non compliance to all the terms and conditions of the NIT.

=====********=====

INTEGRITY PACT

Between

Oil India Limited (OIL) hereinafter referred to as "The Principal"

And

(Name of the bidder).....hereinafter referred to as "The Bidder/Contractor"

Preamble:

The Principal intends to award, under laid down organizational procedures, contract/s for **SDI9228P19** The Principal values full compliance with all relevant laws and regulations, and the principles of economic use of resources, and of fairness and transparency in its relations with its Bidder/s and Contractor/s.

In order to achieve these goals, the Principal cooperates with the renowned international Non-Governmental Organization "Transparency International" (TI). Following TI's national and international experience, the Principal will appoint an external independent Monitor who will monitor the tender process and the execution of the contract for compliance with the principles mentioned above.

Section: 1 -Commitments of the Principal

(1) The Principal commits itself to take all measures necessary to prevent corruption and to observe the following principles:

1. No employee of the Principal, personally or through family members, will in connection with the tender for, or the execution of a contract, demand, take a promise for or accept, for him/herself or third person, any material or immaterial benefit which he/she is not legally entitled to.
2. The Principal will, during the tender process treat all Bidders with equity and reason. The Principal will in particular, before and during the tender process, provide to all Bidders the same information and will not provide to any Bidder confidential/additional information through which the Bidder could obtain an advantage in relation to the tender process or the contract execution.

ANNEXURE- DDD

3. The Principal will exclude from the process all known prejudiced persons.

(2) If the Principal obtains information on the conduct of any of its employees which is a criminal offence under the relevant Anti-Corruption Laws of India, or if there be a Page 2 of 6 substantive suspicion in this regard, the Principal will inform its Vigilance Office and in addition can initiate disciplinary actions.

Section: 2 -Commitments of the Bidder/Contractor

(1) The Bidder/Contractor commits itself to take all measures necessary to prevent corruption. He commits himself to observe the following principles during his participation in the tender process and during the contract execution.

1. The Bidder/Contractor will not, directly or through any other person or firm, offer, promise or give to any of the Principal's employees involved in the tender process or the execution of the contract or to any third person any material or immaterial benefit which he/she is not legally entitled to, in order to obtain in exchange any advantage of any kind whatsoever during the tender process or during the execution of the contract.

2. The Bidder/Contractor will not enter with other Bidders into any undisclosed agreement or understanding, whether formal or informal. This applies in particular to prices, specifications, certifications, Subsidiary contracts, submission or non-submission of bids or any other actions to restrict competitiveness or to introduce cartelization in the bidding process.

3. The Bidder/Contractor will not commit any offence under the relevant Anticorruption Laws of India; further the Bidder/Contractor will not use improperly, for purposes of competition or personal gain, or pass on to others, any information or document provided by the Principal as part of the business relationship, regarding plans, technical proposals and business details, including information contained or transmitted electronically.

4. The Bidder/Contractor will, when presenting his bid, disclose any and all payments he has made, is committed to or intends to make to agents, brokers or any other intermediaries in connection with the award of the contract.

(2) The Bidder/Contractor will not instigate third persons to commit offences outlined above or be an accessory to such offences.

(3) The Bidder/Contractor signing Integrity Pact shall not approach the Courts while representing the matters to IEMs and he/she will await their decision in the matter.

Section 3 -Disqualification from tender process and exclusion from future Contracts

If the Bidder, before contract award has committed a transgression through a violation of Section 2 or in any other form such as to put his reliability or risibility as Bidder into question, the Principal is entitled to disqualify the Bidder from the tender process or to terminate the contract, if already signed, for such reason.

1. If the Bidder/Contractor has committed a transgression through a violation of Section 2 such as to put his reliability or credibility into question, the Principal is entitled also to exclude the Bidder/Contractor from future contract award processes. The imposition and duration of the exclusion will be determined by the severity of the transgression. The severity will be determined by the circumstances of the case, in particular the number of transgressions, the position of the transgressions within the company hierarchy of the Bidder and the amount of the damage. The exclusion will be imposed for a minimum of 6 months and maximum of 3 years.
2. The Bidder accepts and undertakes to respect and uphold the Principal's Absolute right to resort to and impose such exclusion and further accepts and undertakes not to challenge or question such exclusion on any ground, including the lack of any hearing before the decision to resort to such exclusion is taken. This undertaking is given freely and after obtaining independent legal advice.
3. If the Bidder/Contractor can prove that he has restored/recouped the Damage caused by him and has installed a suitable corruption prevention system, the Principal may revoke the exclusion prematurely.
4. A transgression is considered to have occurred if in light of available evidence no reasonable doubt is possible.
5. Integrity Pact, in respect of a particular contract, shall be operative from the date Integrity Pact is signed by both the parties till the final completion of the contract **or as mentioned in Section 9- Pact Duration whichever is later**. Any violation of the same would entail disqualification of the bidders and exclusion from future business dealings

Section 4 -Compensation for Damages

1. If the Principal has disqualified the Bidder from the tender process prior to the award according to Section 3, the Principal is entitled to demand and recover from the Bidder liquidated damages equivalent to Earnest Money Deposit / Bid Security.

(2) If the Principal has terminated the contract according to Section 3, or if the Principal is entitled to terminate the contract according to Section 3, the principal shall be entitled to demand and recover from the Contractor liquidated damages equivalent to Security Deposit / Performance Bank Guarantee.

3. The bidder agrees and undertakes to pay the said amounts without protest or demur subject only to condition that if the Bidder/Contractor can prove and establish that the exclusion of the Bidder from the tender process or the termination of the contract after the contract award has caused no damage or less damage than the amount or the liquidated damages, the Bidder/Contractor shall compensate the Principal only to the extent of the damage in the amount proved.

Section 5 -Previous transgression

1. The Bidder declares that no previous transgression occurred in the last 3 years with any other Company in any country conforming to the TI approach or with any other Public Sector Enterprise in India that could justify his exclusion from the tender process.

2. If the Bidder makes incorrect statement on this subject, he can be disqualified from the tender process or the contract, if already awarded, can be terminated for such reason.

Section: 6 -Equal treatment of all Bidders/Contractor/Subcontractors

1. The Principal will enter into Pacts on identical terms with all bidders and contractors.

2. The Bidder / Contractor undertake(s) to procure from all subcontractors a commitment in conformity with this Integrity Pact. The Bidder/Contractor shall be responsible for any violation(s) of the provisions laid down in this agreement/Pact by any of its sub-contractors/sub-vendors.

3. The Principal will disqualify from the tender process all bidders who do not sign this Pact or violate its provisions.

Section: 7 -Criminal charges against violating Bidders/Contractors/ Subcontractors

If the Principal obtains knowledge of conduct of a Bidder, Contractor or Subcontractor, or of an employee or a representative or an associate of a Bidder, Contractor or Subcontractor, which constitutes corruption, or if the Principal has substantive suspicion in this regard, the Principal will inform the Vigilance Office.

Section: 8 -External Independent Monitor/Monitors

1. The Principal appoints competent and credible external independent Monitor for this Pact. The task of the Monitor is to review independently and objectively, whether and to what extent the parties comply with the obligations under this agreement.
2. The Monitor is not subject to instructions by the representatives of the parties and performs his functions neutrally and independently. He reports to the Chairperson of the Board of the Principal.
3. The Contractor accepts that the Monitor has the right to access without restriction to all Project documentation of the Principal including that provided by the Contractor. The Contractor will also grant the Monitor, upon his request and demonstration of a valid interest, unrestricted and unconditional access to his project documentation. The same is applicable to Subcontractors. The Monitor is under contractual obligation to treat the information and documents of the Bidder/Contractor/Subcontractor with confidentiality.
4. The Principal will provide to the Monitor sufficient information about all meetings among the parties related to the Project provided such meetings could have an impact on the contractual relations between the Principal and the Contractor. The parties offer to the Monitor the option to participate in such meetings.
5. As soon as the Monitor notices, or believes to notice, a violation of this agreement, he will so inform the Management of the Principal and request the Management to discontinue or heal the violation, or to take other relevant action. The monitor can in this regard submit non-binding recommendations. Beyond this, the Monitor has no right to demand from the parties that they act in a specific manner, refrain from action or tolerate action. However, the Independent External Monitor shall give an opportunity to the bidder / contractor to present its case before making its recommendations to the Principal.
6. The Monitor will submit a written report to the Chairperson of the Board of the Principal within 8 to 10 weeks from the date of reference or intimation to

ANNEXURE- DDD

him by the 'Principal' and, should the occasion arise, submit proposals for correcting problematic situations.

7. If the Monitor has reported to the Chairperson of the Board a Substantiated suspicion of an offence under relevant Anti-Corruption Laws of India, and the Chairperson has not, within reasonable time, taken visible action to proceed against such offence or reported it to the Vigilance Office, the Monitor may also transmit this information directly to the Central Vigilance Commissioner, Government of India.

8. The word 'Monitor' would include both singular and plural.

Section:9 -Pact Duration

This Pact begins when both parties have legally signed it. It expires for the Contractor 12 months after the last payment under the respective contract, and for all other Bidders 6 months after the contract has been awarded.

If any claim is made/ lodged during this time, the same shall be binding and continue to be valid despite the lapse of this pact as specified above, unless it is discharged/determined by Chairperson of the Principal.

Section:10 -Other provisions

1. This agreement is subject to Indian Law. Place of performance and jurisdiction is the Registered Office of the Principal, i.e. New Delhi. The Arbitration clause provided in the main tender document / contract shall not be applicable for any issue / dispute arising under Integrity Pact.

2. Changes and supplements as well as termination notices need to be made in writing. Side agreements have not been made.

3. If the Contractor is a partnership or a consortium, this agreement must be, signed by all partners or consortium members.

4. Should one or several provisions of this agreement turn out to be invalid, the remainder of this agreement remains valid. In this case, the parties will strive to come to an agreement to their original intentions.

A J SARMAH
SMM (IP)

.....
For the Principal

.....
For the Bidder/Contractor

Witness 1:

Witness 2:

Place. DULIAJAN
Date . 18.09.2018

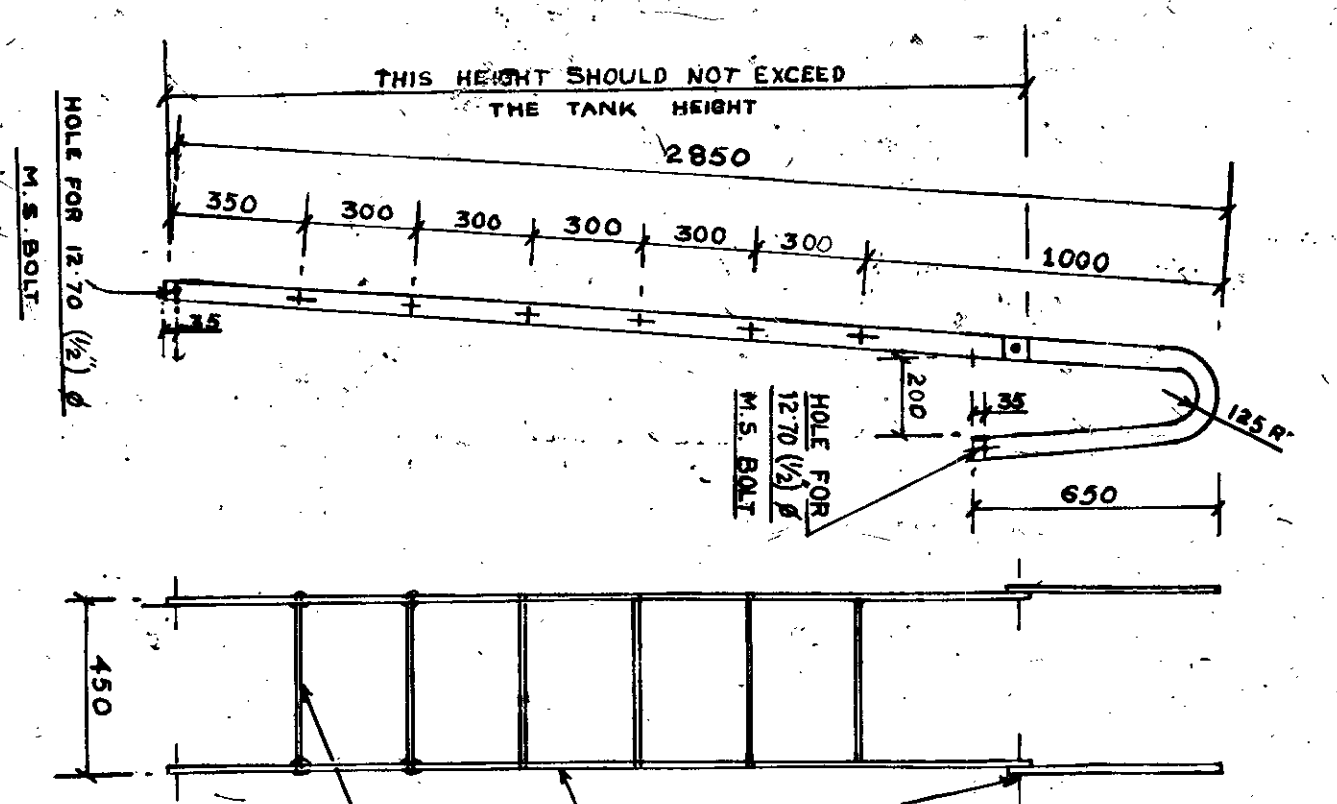

OUTER LADDER

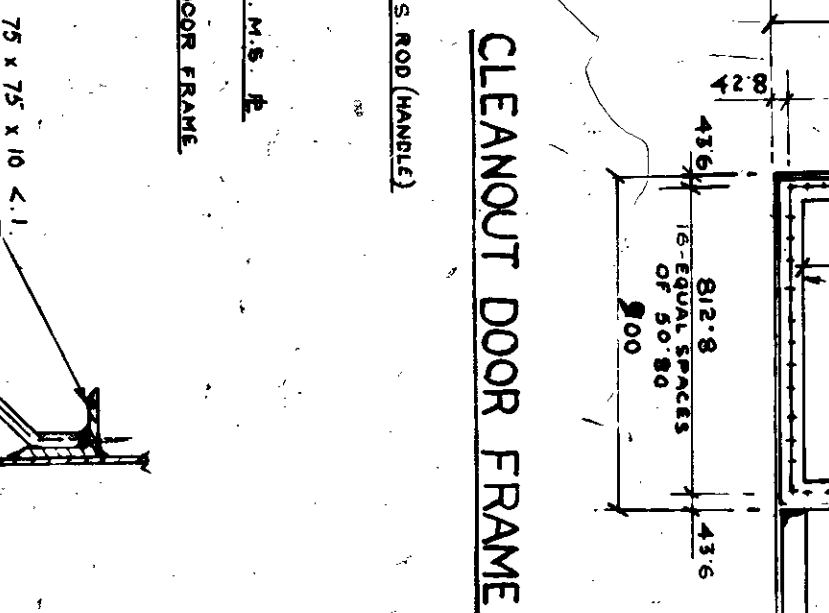
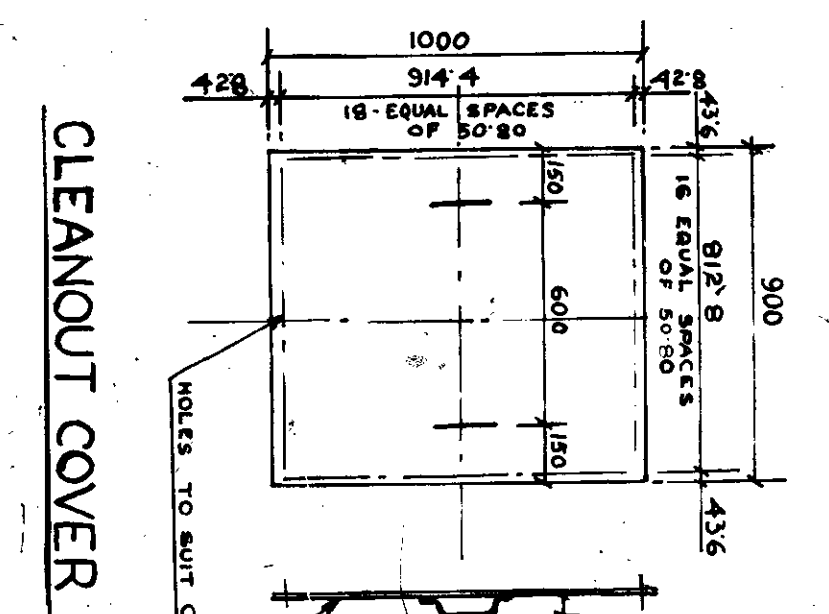

DETAIL OF BASE β WITH STAY ROD

DETAIL OF MANHOLE DOOR FRAME
READ - 3-OFF

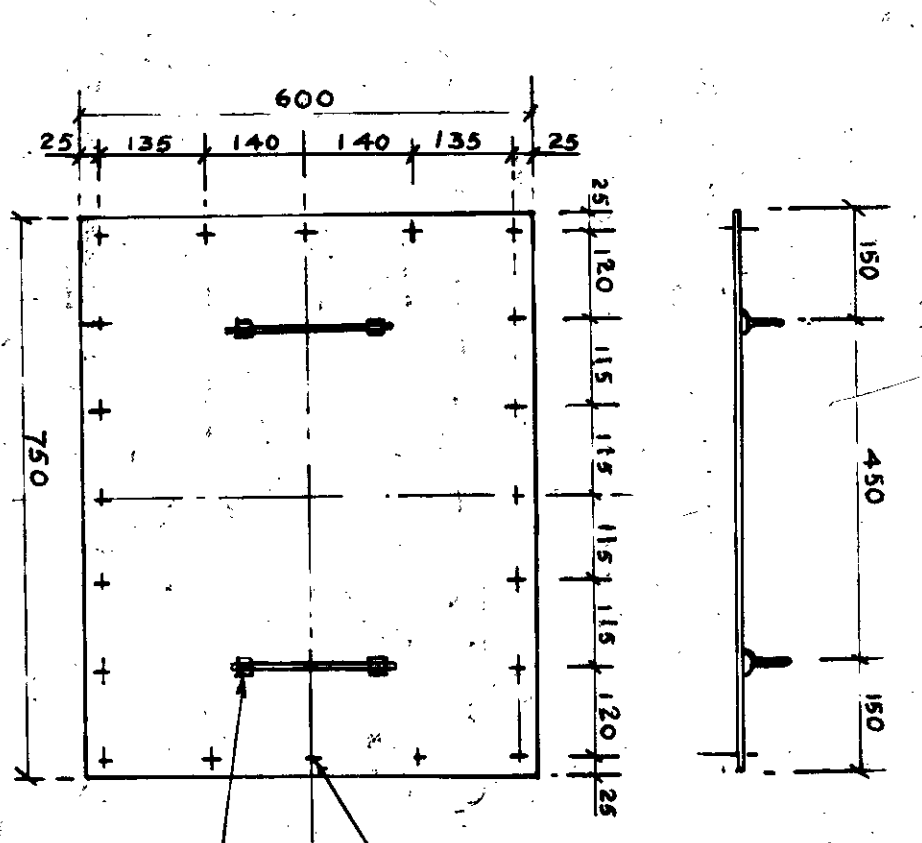

DETAIL OF MANHOLE COVER
READ - 3-OFF

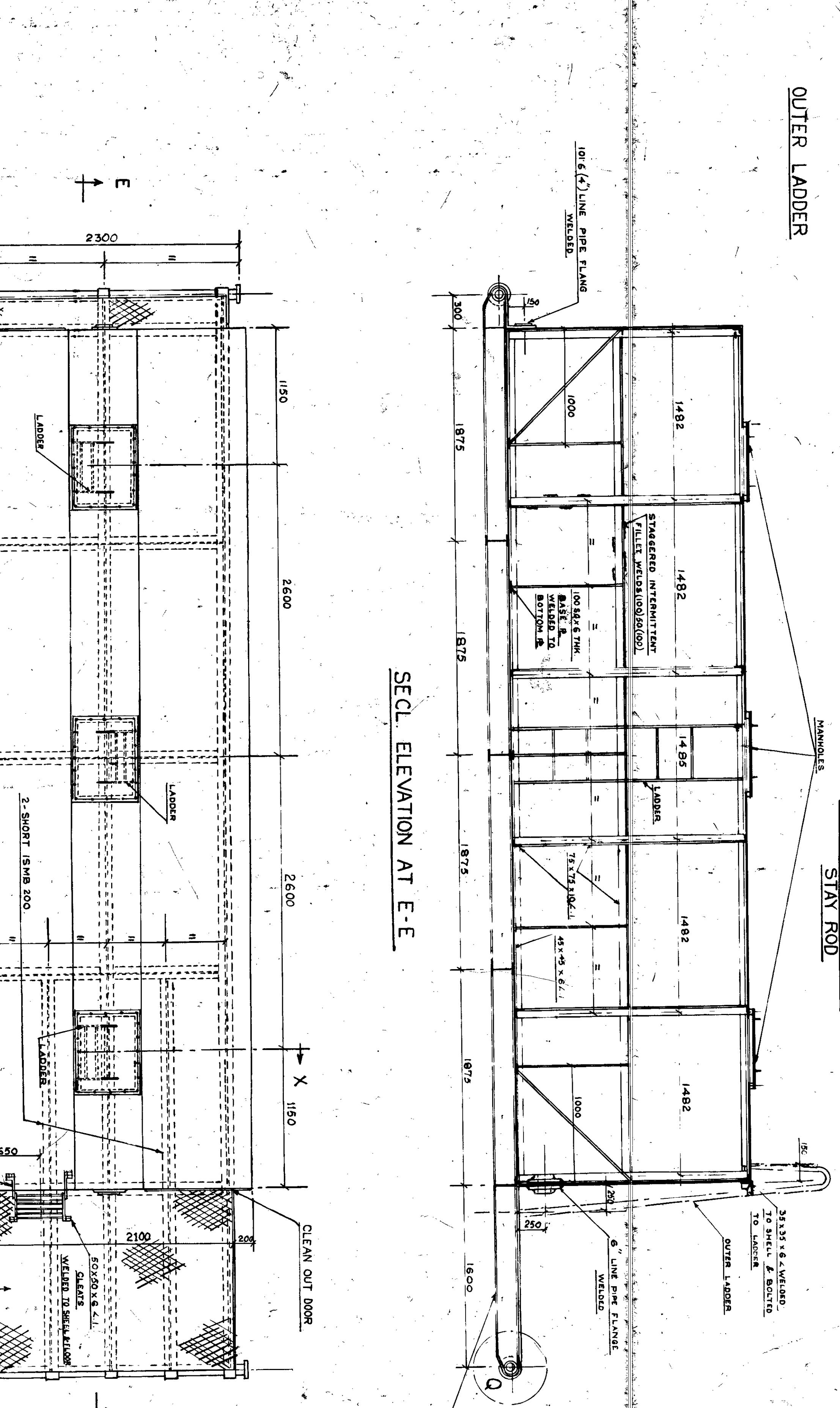
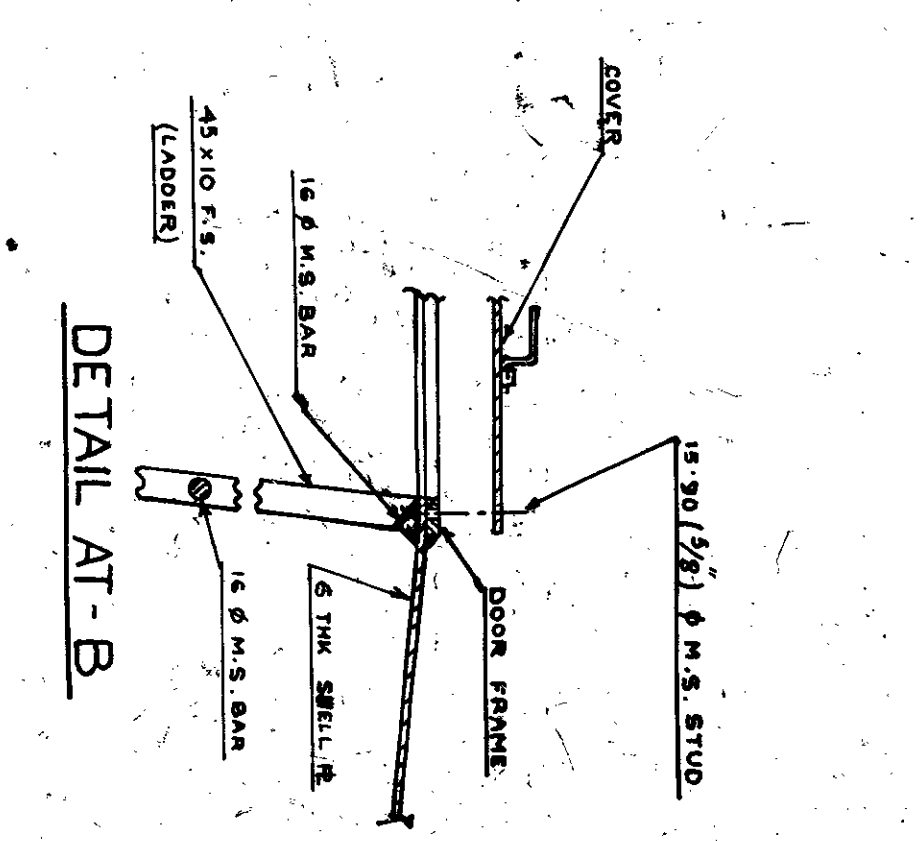
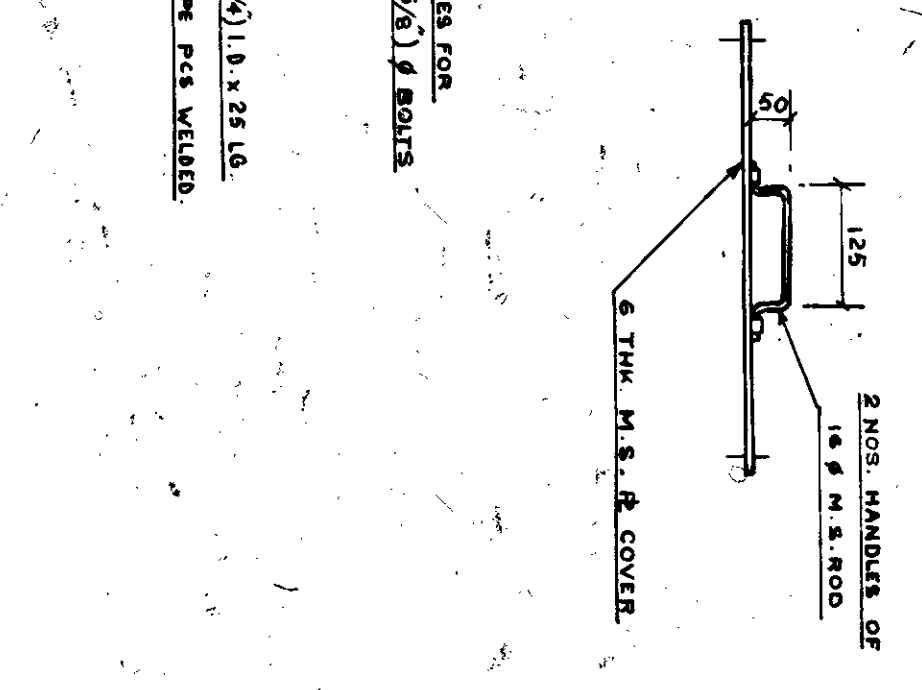

SECT. ELEVATION AT E-E

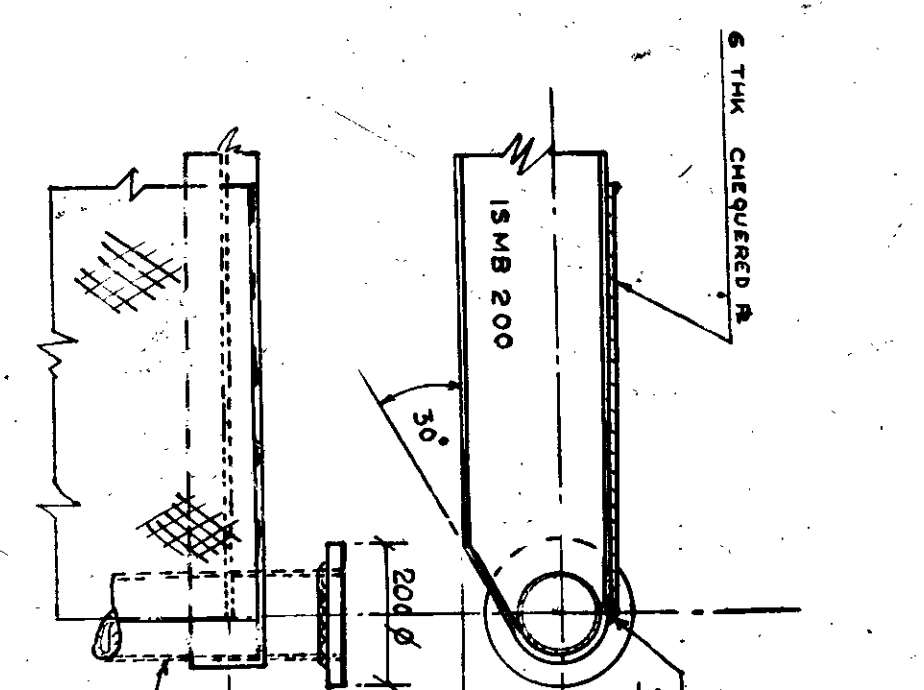

DETAIL AT Q

SEC - X-X
(WITH OUTER LADDER REMOVED)

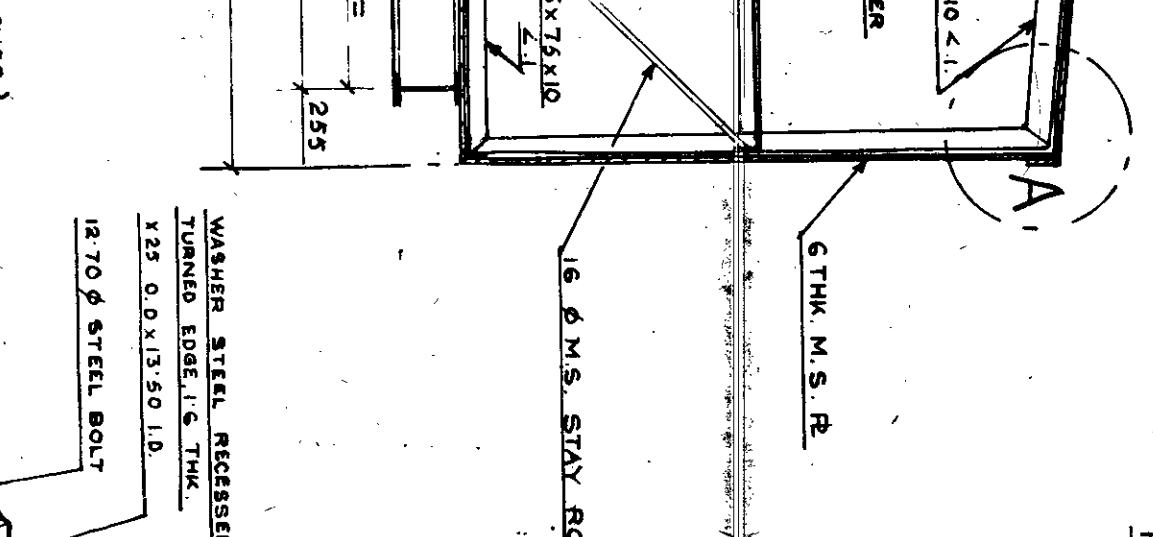

DETAIL AT-A

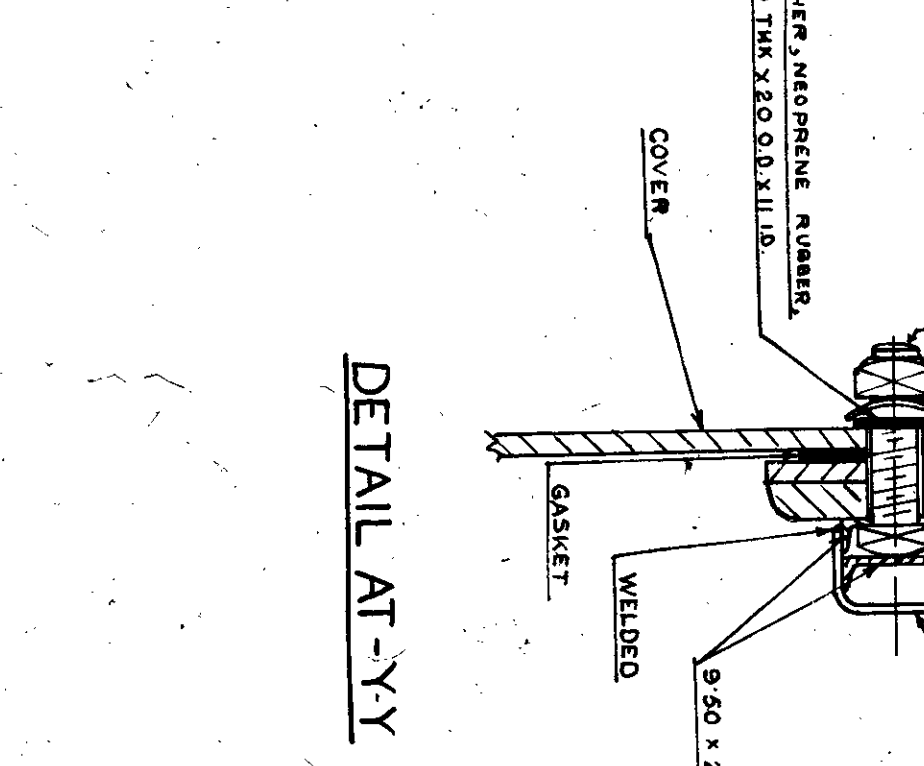

DETAIL AT-Y-Y

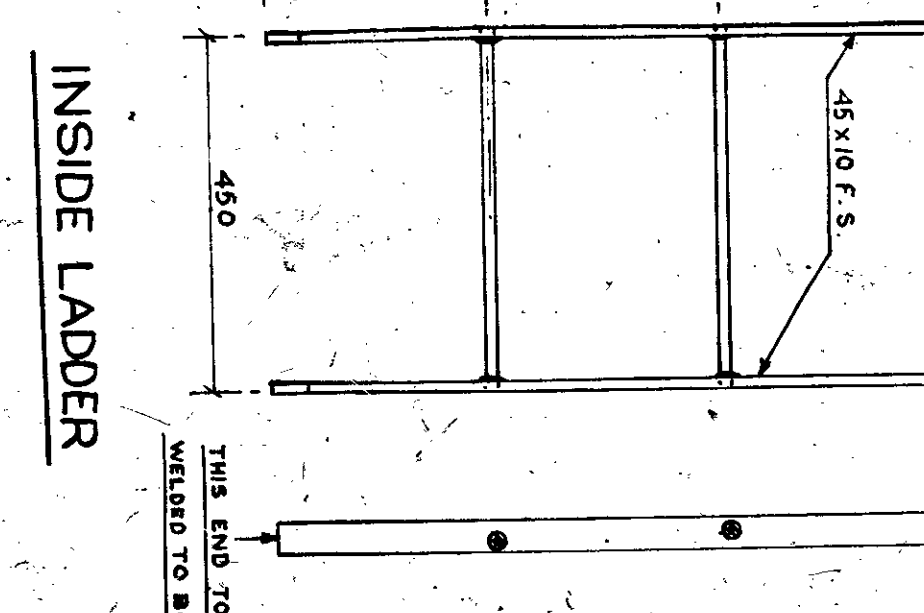

INSIDE LADDER

NOTE:-
SUITABLE FOR TRANSPORTATION BY B.F.R.
BOGIE RAIL WAGON.

C	24885	DISCREPANCY OF MANHOLE COVER/DOOR
B	17474	ADDITIONAL TWO SHORT ISMB 200 PROVIDED

RETRACTED ON 13.6.84
OIL INDIA LIMITED
DULIAJAIN
DIRS NY OIL/2984/C
SUBJECT 240 BBL (US) SKID
MOUNTED RECTANGULAR MUD TANK
SCALE 1:25, 1:50 & 1:10
SURVEYED

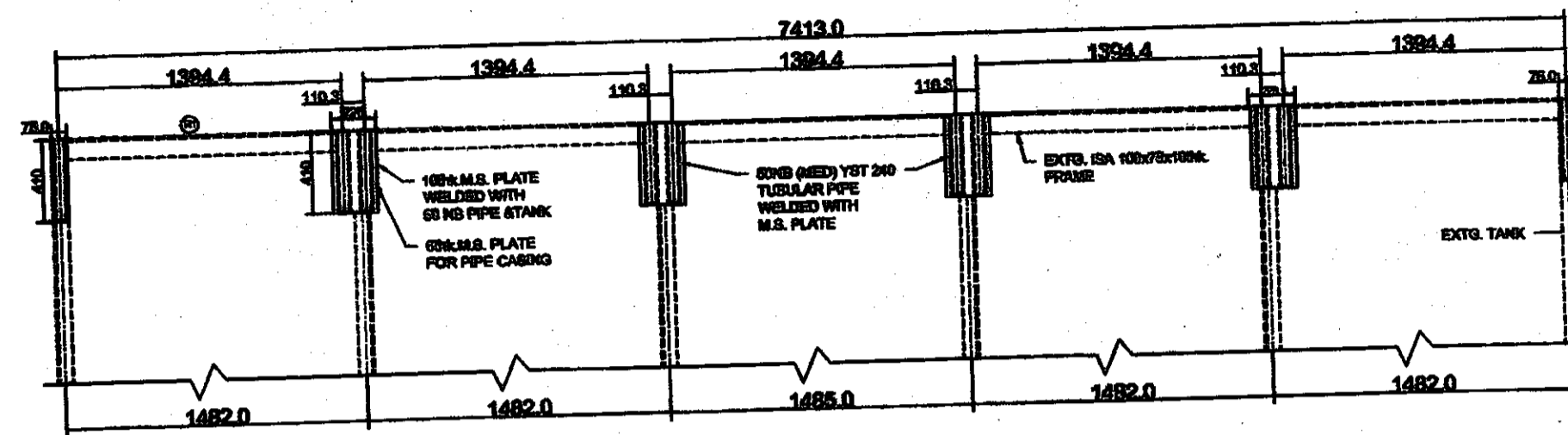

ELEVATION

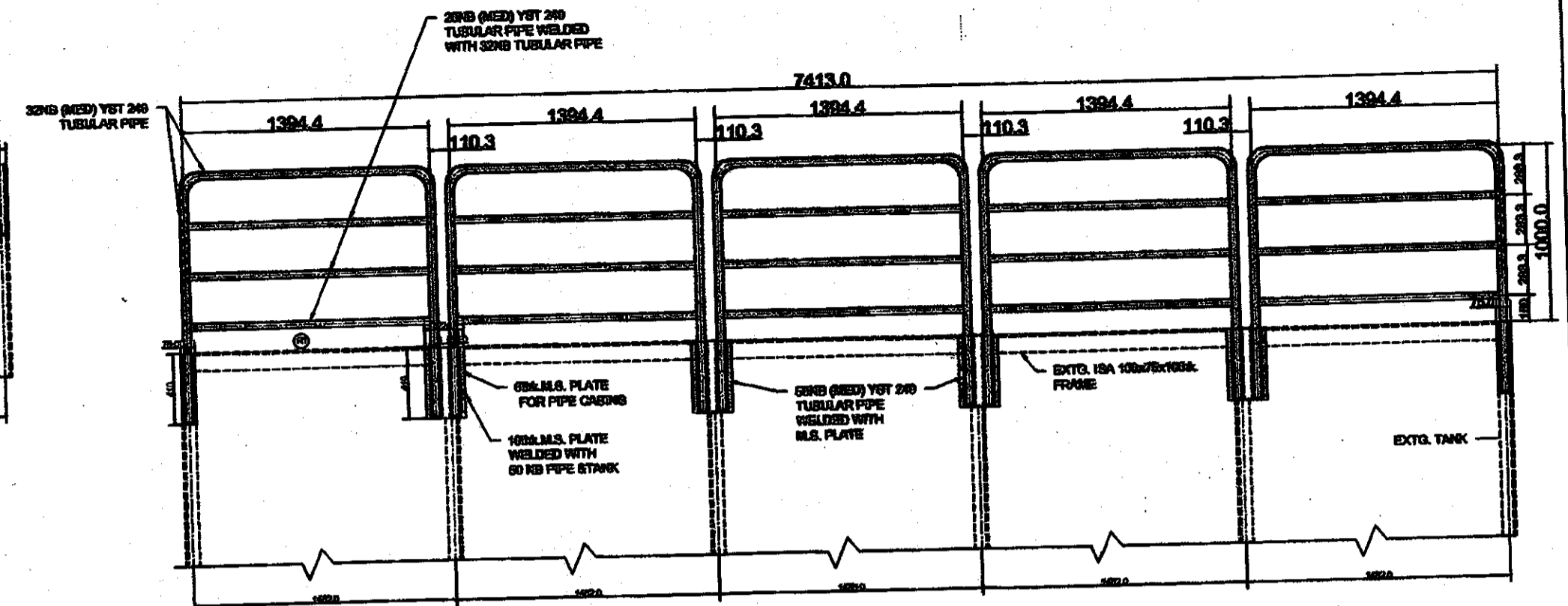

**ELEVATION
(SHOWING RAILING)**

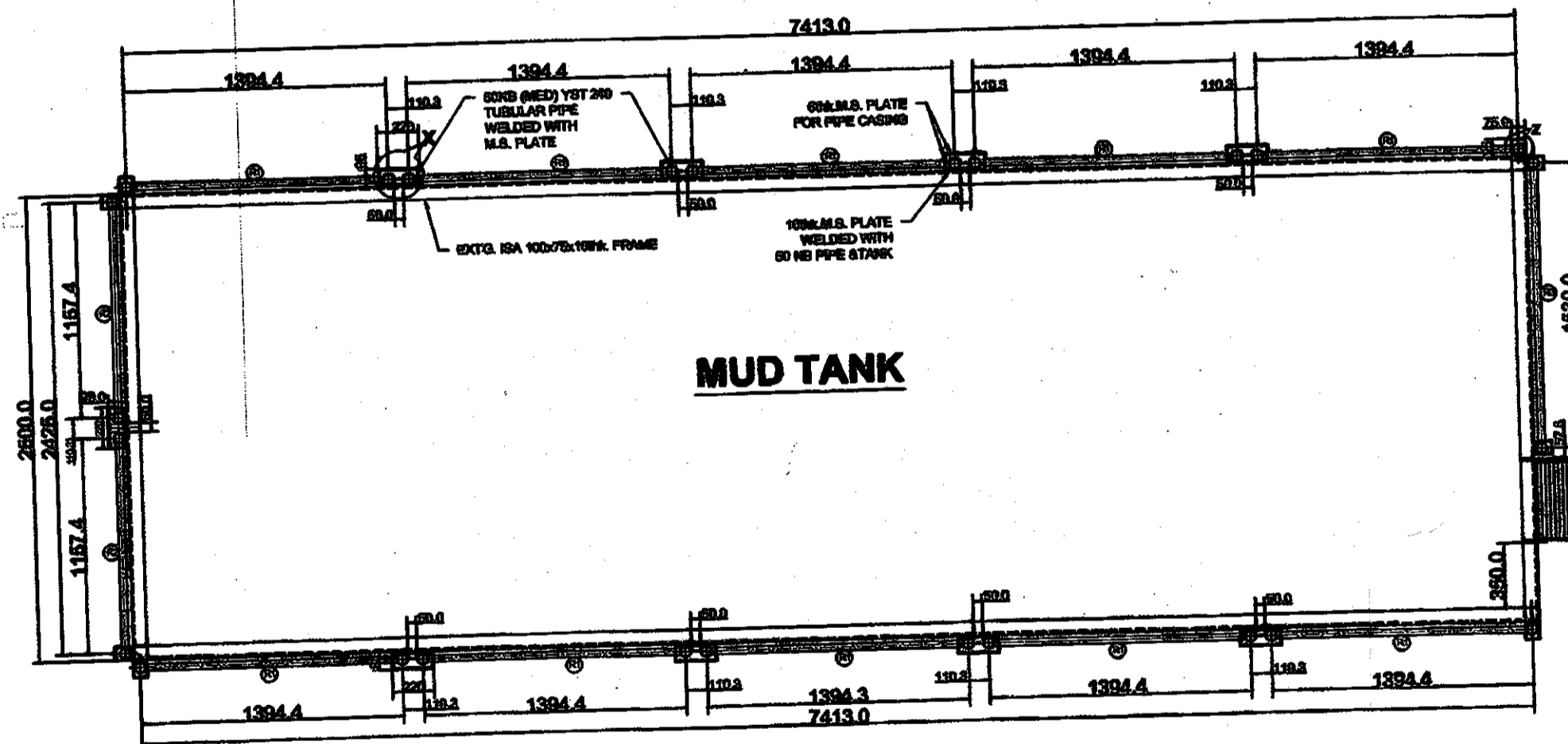

MUD TANK

PLAN

NOTES:-

1. ALL STRUCTURAL TUBULAR STEEL SHALL BE IN ACCORDANCE WITH IS:1161-1968 & IS:806-1968.
2. ALL STRUCTURAL STEEL WORKS SHALL CONFORM TO IS:800-1984 & IS:226-1975.
3. FLAT STEEL CONFORMING TO IS:1731-1971.
4. WELDING WORKS SHALL CONFORM TO IS:823-1984 & IS:816-1969.

ALL DIMENSIONS ARE IN MILLIMETRE

APPROVED BY - *DeKa*
 NAME - UTPAL DEKA
 DESIGNATION - Dy. CEPO (P&D)
 DATE - 08/01/2015

REF. DRG. :

FOR DETAIL OF CONNECTION REF. DRG. NO. OIL /10405

	OIL INDIA LIMITED DRAWING OFFICE DULIAJAN	DESIGNED	NAME	DATE
		DRAWN	D.GOGOI	18.12.14
SCALE 1:32	TITLE GUARD RAILING ON 37.37 KL RECTANGULAR TANKS (GENERAL ARRGT.)	TRACED		
		CHECKED		
	DRG. No. OIL/10404	APPROVED		

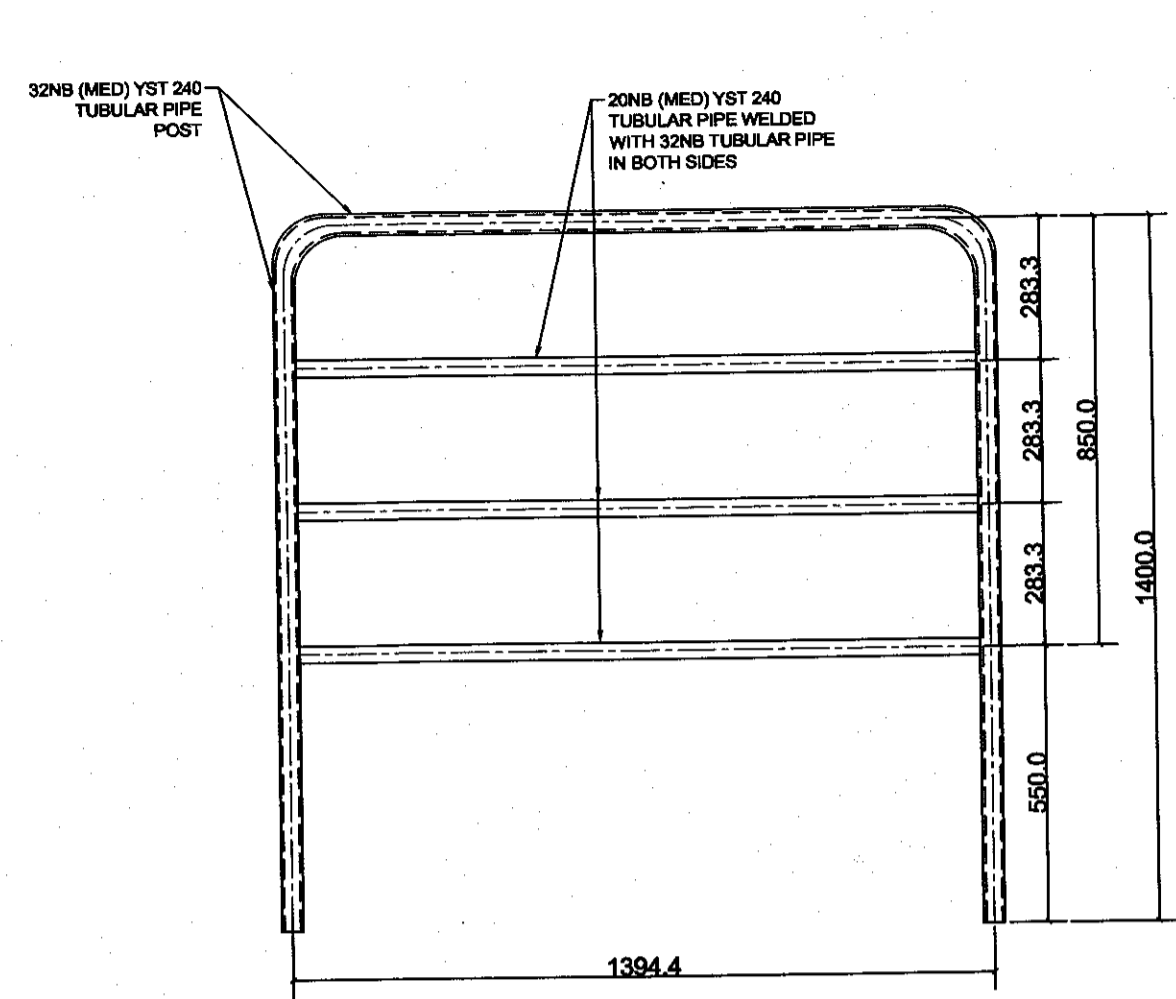

ELEVATION

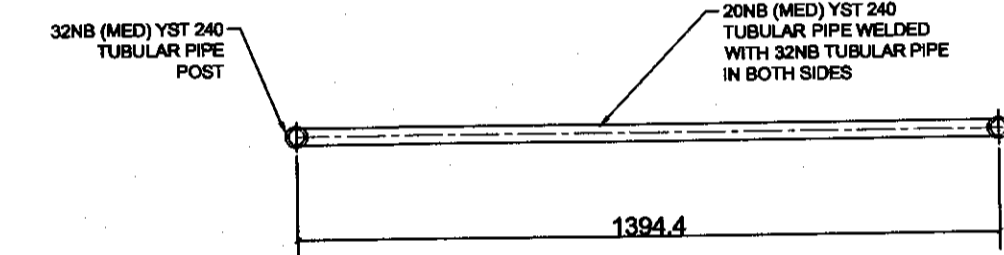

**PLAN
DETAIL OF RAILING - (R1)
REQD. - 10 nos.**

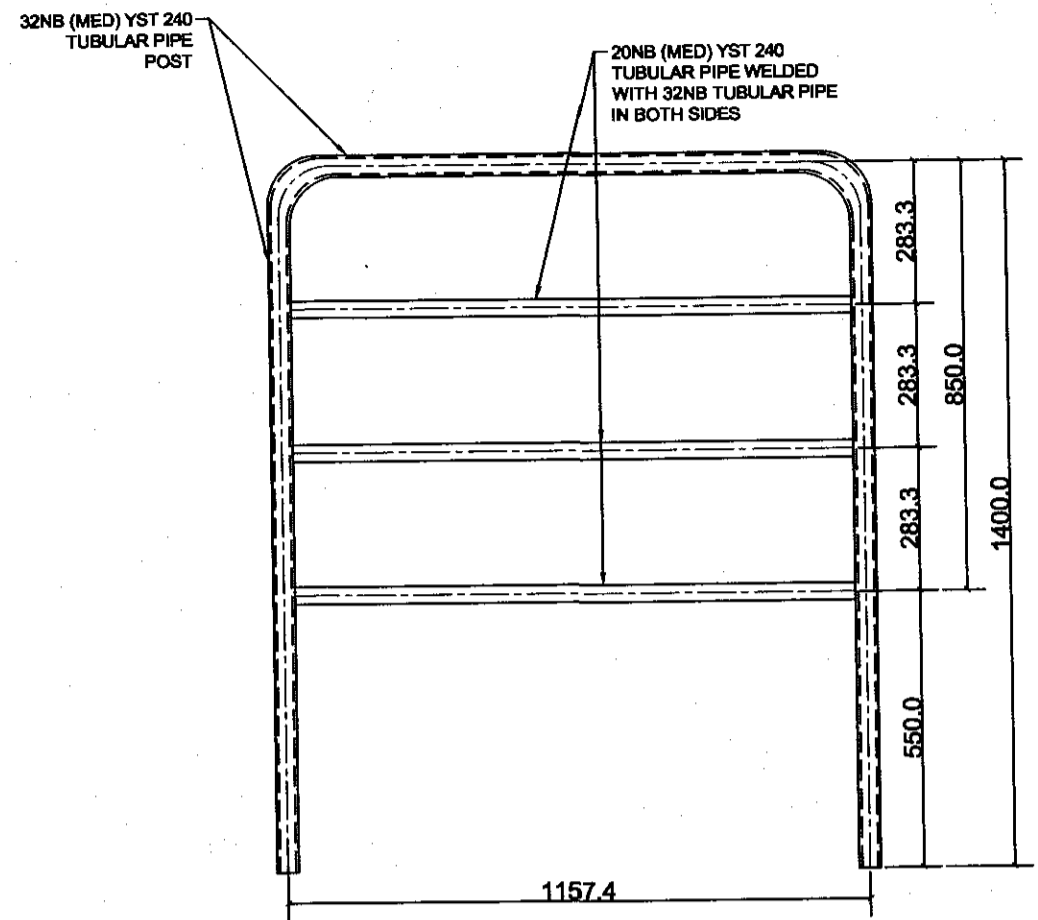

ELEVATION

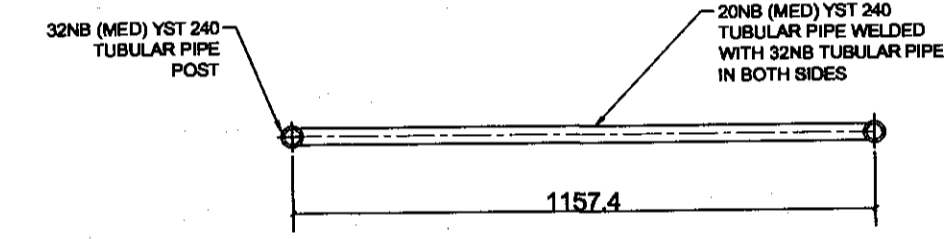

**PLAN
DETAIL OF RAILING - (R2)
REQD. - 2 nos.**

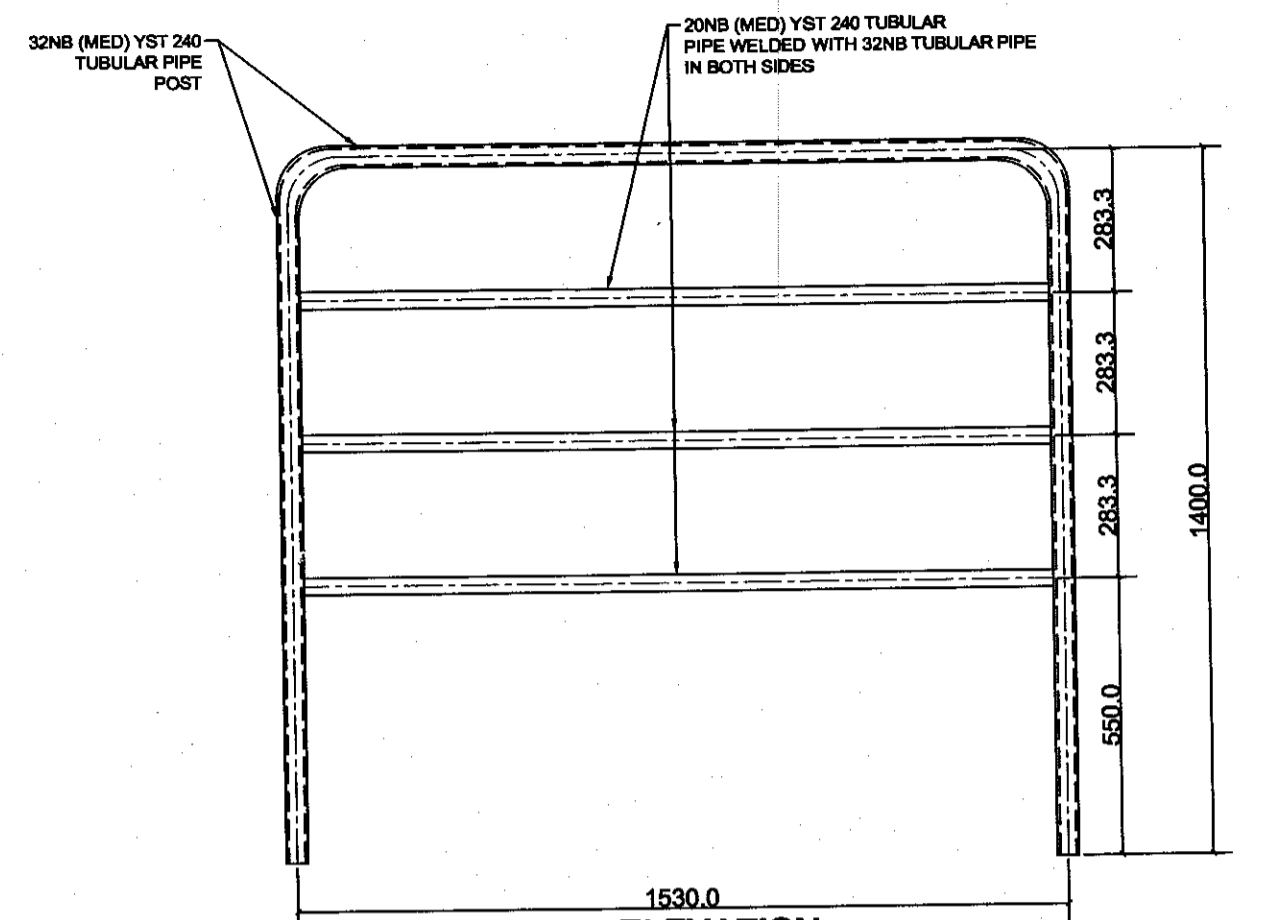

ELEVATION

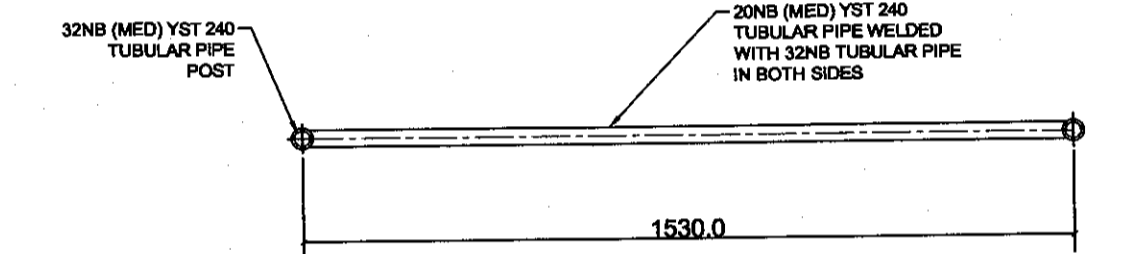

**PLAN
DETAIL OF RAILING - (R3)
REQD. - 1 nos.**

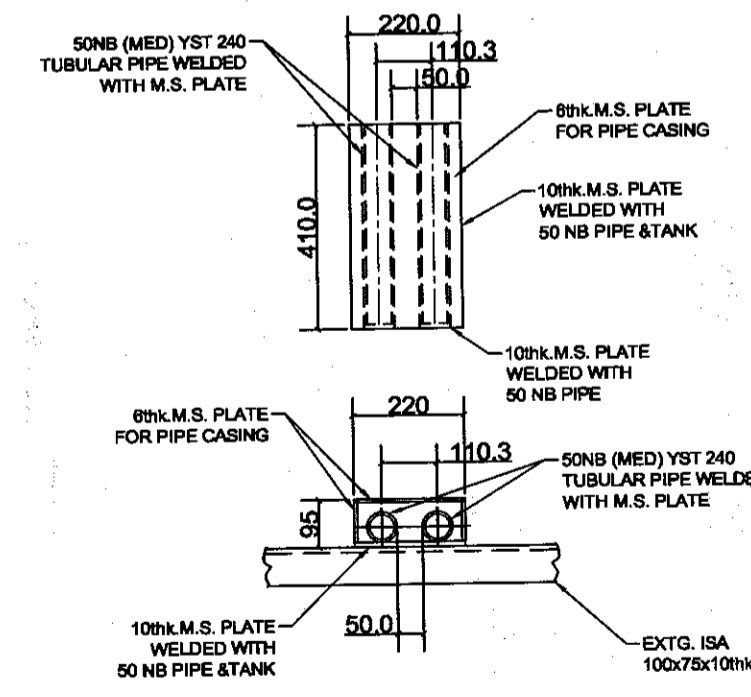

ENLARGED DETAIL AT 'X'

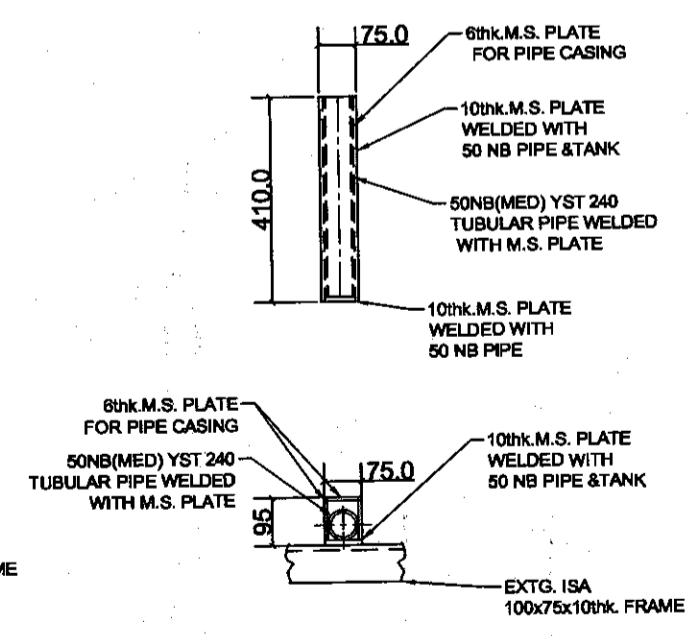

ENLARGED DETAIL AT 'Z'

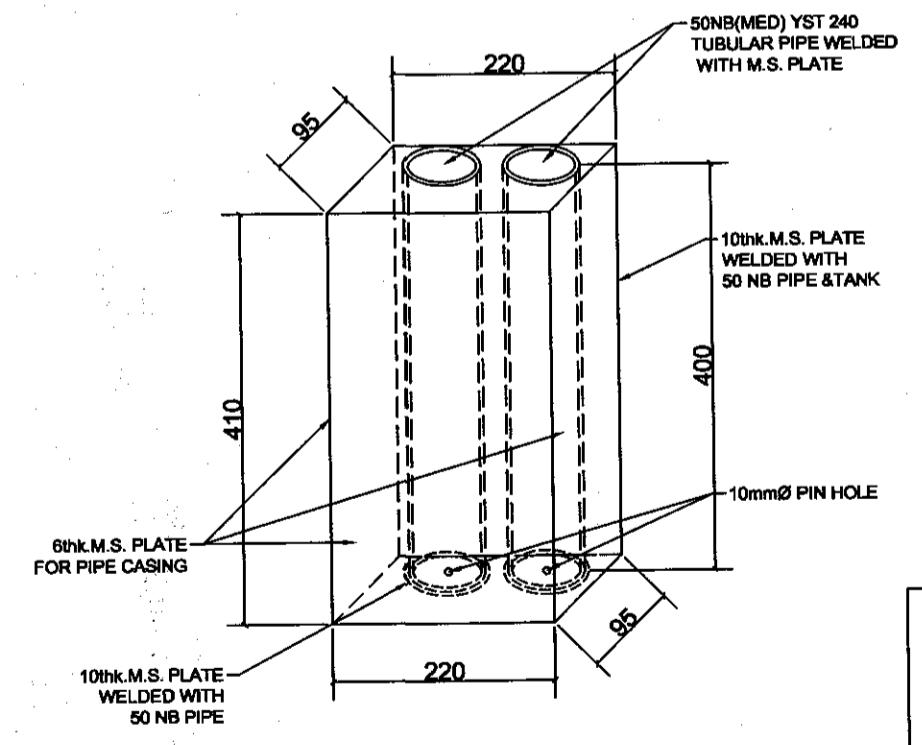

ISOMETRIC VIEW

REF. DRG. :

FOR GENERAL ARRGT. REF. DRG. NO. OIL /10404

ALL DIMENSIONS ARE IN MILLIMETRE

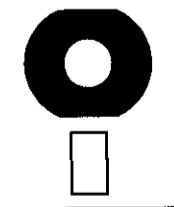
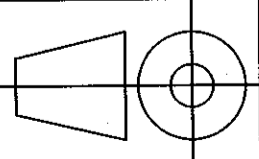
 SCALE 1:15	OIL INDIA LIMITED DRAWING OFFICE DULIAJAN TITLE GUARD RAILING ON 37.37 KL RECTANGULAR TANKS (DETAIL OF CONNECTION)	DESIGNED	NAME	DATE
		DRAWN	D.GOGOI	13.12.14
		TRACED		
		CHECKED		
		APPROVED		
			DRG. No.	
			OIL/10405	

Technical Bid Checklist**Annexure-EEE**

Tender No.			
Bidder's Name :			
		Compliance by Bidder	
Sl. NO.	BEC / TENDER REQUIREMENTS	Indicate 'Confirmed' / 'Not Confirmed' / Not applicable	Indicate Corresponding page ref. of unpriced bid or Comments
1	Confirm that validity has been offered as per NIT.		
2	Confirm that Bid Security / Earnest Money has been submitted as per NIT (Wherever Applicable) ?		
3	Confirm that you shall submit Performance security (in the event of placement of order) (Wherever Applicable) ?		
4	Confirm that duly signed Integrity Pact has been submitted as per NIT (Wherever Applicable) ?		
5	Confirm that you have submitted documentary evidence of successfully executing one Purchase order as stipulated in NIT in any of the preceding 5 financial years (*)		
6	Confirm that you have submitted Balance Sheet and Profit and Loss Account of any of the preceding 3 financial years certified by a chartered accountant.		
7	Confirm that the bid has been signed using Class 3 digital certificate with Organisation's Name as per NIT.		
8	Confirm that you have not taken any exception/deviations to the NIT .		

NOTE: Please fill up the greyed cells only.

(*) Purchase Orders along with copies of any of the documents in respect of satisfactory execution of the Purchase Orders should be submitted – (i) Satisfactory Inspection Report (OR) (ii) Satisfactory Supply Completion / Installation Report (OR) (iii) Consignee Received Delivery Challans (OR) (iv) Central Excise Gate Pass / Tax , Invoices issued under relevant rules of Central Excise / VAT (OR) (v) any other documentary evidence that can substantiate the satisfactory execution of the purchase order cited above.

Response Sheet

Annexure-FFF

Tender No.
Bidders Name

Bidders Response Sheet

SI No.	Description	Remarks
1	Place of Despatch	
2	Whether Freight charges have been included in your quoted prices	
3	Whether Insurance charges have been included in your quoted prices	
4	Make of quoted Product	
5	Offered Validity of Bid as per NIT	
6	Bid Security Submitted (if applicable)	
6	Details of Bid Security Submitted to OIL (if applicable)	
	a) Bid Security Amount (In Rs):	
	b) Bid Security Valid upto:	
7	Whether you shall submit Performance Security in the event of placement of order on you (if applicable)	
8	Integrity Pact Submitted (if applicable)	
9	Whether you have submitted documentary evidence of successfully executing one Purchase order as stipulated in NIT in any of the preceding 5 financial years (*)	
10	Whether you have submitted Balance Sheet and Profit and Loss Account of any of the preceding 3 financial years certified by a chartered accountant.	
11	Delivery Period in weeks from placement of order	
12	Complied to Payment terms of NIT (if applicable) otherwise to Standard Payment Terms of OIL or not.	
13	If bidder is MSE whether you have quoted your own product	
14	If Bid security submitted as Bank Guarantee, Name and Full Address of Issuing Bank including Telephone, Fax Nos and Email id of branch manager	

NOTE: Please fill up the greyed cells only.

(*) Purchase Orders along with copies of any of the documents in respect of satisfactory execution of the Purchase Orders should be submitted – (i) Satisfactory Inspection Report (OR) (ii) Satisfactory Supply Completion / Installation Report (OR) (iii) Consignee Received Delivery Challans (OR) (iv) Central Excise Gate Pass / Tax , Invoices issued under relevant rules of Central Excise / VAT (OR) (v) any other documentary evidence that can substantiate the satisfactory

**(TO BE FILLED UP BY ALL THE VENDOR IN THEIR OWN LETER HEAD)
(ALL FIELDS ARE MANDATORY)**

Tender No. :.....
Name of Beneficiary :M/s.....
Vendor Code :.....
Address :.....
.....
Phone No. (Land Line) :.....
Mobile No. :.....
E-mail address :.....
Bank Account No. (Minimum
Eleven Digit No.) :.....
Bank Name :.....
Branch :.....
Complete Address of your
Bank :.....
IFSC Code of your Bank
a) RTGS :.....
b) NEFT :.....
PAN :.....
VAT Registration No. :.....
CST Registration No. :.....
Service Tax Registration No. :.....
Provident Fund Registration :.....

I/We confirm and agree that all payments due to me/us from Oil India Limited can be remitted to our above mentioned account directly and we shall not hold Oil India Limited responsible if the amount due from Oil India Limited is remitted to wrong account due to incorrect details furnished by us.

Office Seal

.....
Signature of Vendor

Counter Signed by Banker:
Seal of Bank:

Enclosure: Self attested photocopies of the following documents-

- 1) PAN Card
- 2) VAT Registration Certificate
- 3) Service Tax Registration
- 4) CST Registration
- 5) Provident Registration Certificate
- 6) Cancelled cheque of the bank account mentioned above (in original).
- 7) Bank Statement not older than 15 days on the date of submission.